

NOTES

MATERIAL - DIECAST ALUMINUM ALLOY  
 - FOUR M6 CAPTIVE SCREWS

POWDER COATED - Col. RAL 7032  
 POLYURETHANE GASKET  
 -40°C TO +80°C TEMP. RANGE

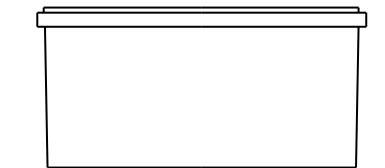
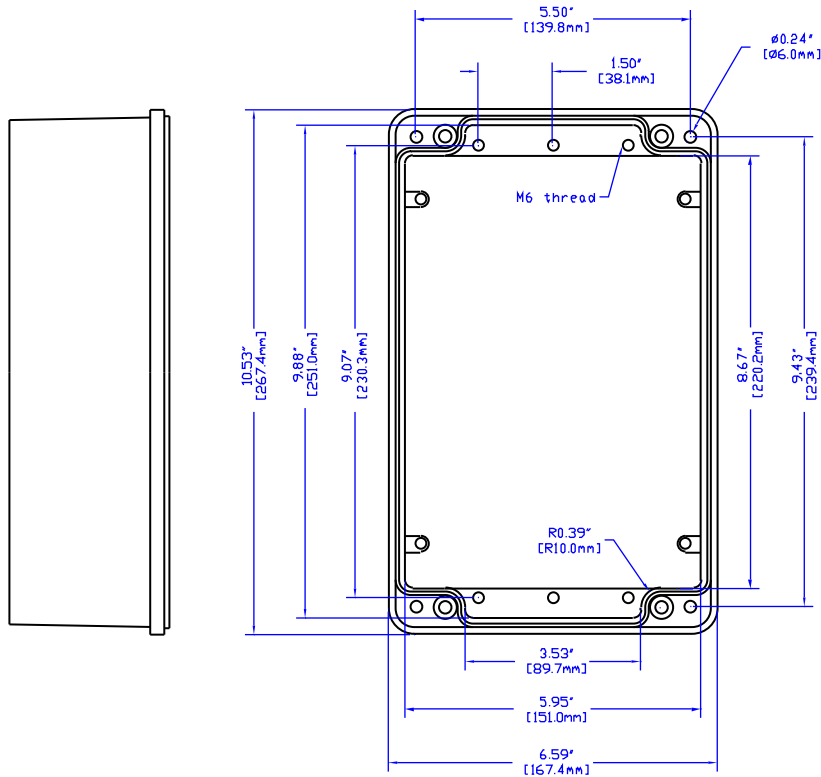
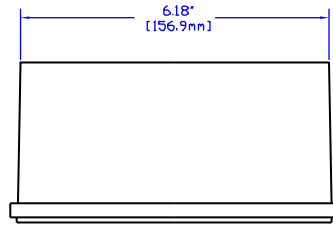

VIEW OF BOX (LID REMOVED)

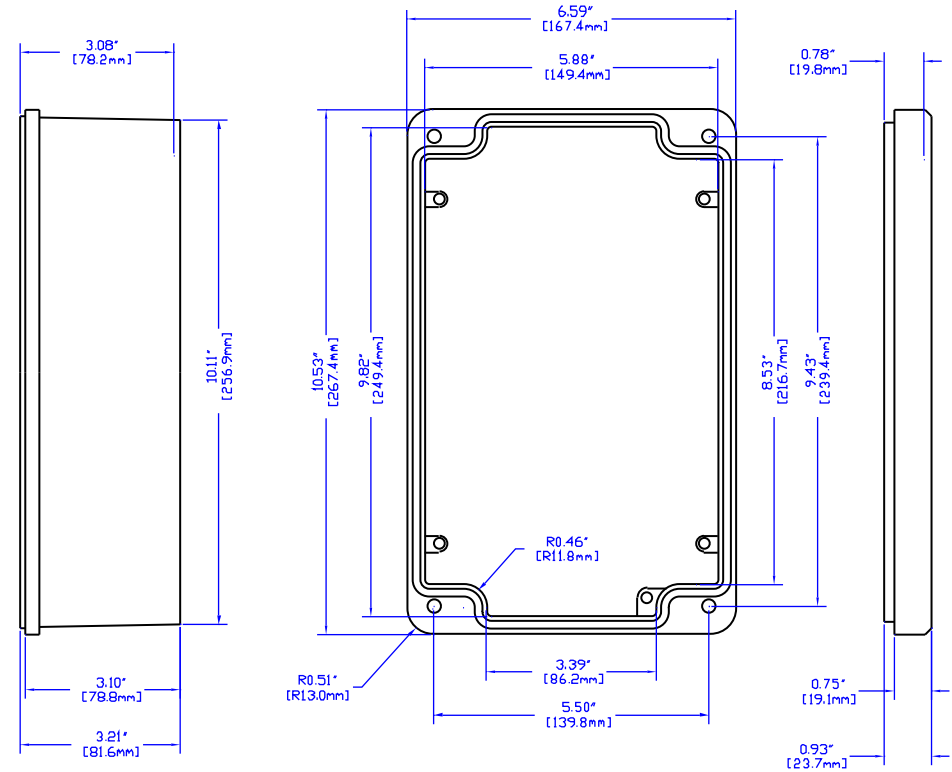

VIEW OF LID (INSIDE)



HAMMOND MANUFACTURING

R110-162-000

CANADA - PH (519) 886 7170 - FAX (519) 886 8311  
 U.S.A. - PH (716) 631 5700 - FAX (716) 631 1156